

# Concerning Compact Discs



Only compact discs bearing this mark can be used with this unit.

However, continued use of irregular shape CDs can damage the unit.



How to remove a disc from its case

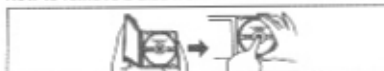

How to store the disc in its case



How to hold a disc



If the surface is dirty

Wipe it with a damp cloth and then wipe dry. Wipe from the center toward the outer circumference.

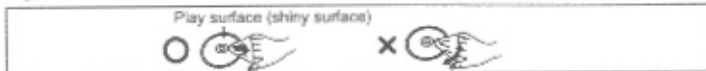

If moisture has formed on a disc

When moisture has formed because the disc was brought suddenly into a warm room from a cold environment, wipe it off using a soft dry cloth.

When storing discs

- Avoid locations which are
  - Exposed to direct sunlight.
  - Susceptible to high levels of humidity or dust.
  - Directly exposed to heat from a heating appliance.
  - On top of a car dashboard or near the rear window.

Handling precautions

- On the label side (the side with writing)
  - Do not write anything using a pencil, ball-point pen, etc. Do not stick paper or labels.
- On the disc (shiny) side
  - Handle this side carefully to keep it free from fingerprints or scratches. Do not use record cleaners, solvents, etc.
  - Do not attach labels or stickers to CD's.
  - Do not use CDs with exposed adhesive from tape or left over peeled off stickers.
  - Do not use scratch-proof protectors or covers other than those specified for use with this unit.

Panasonic Consumer Electronics Company, Division of Matsushita Electric Corporation of America

One Panasonic Way Secaucus, New Jersey 07094 <http://www.panasonic.com>

Panasonic Sales Company, Division of Matsushita Electric of Puerto Rico, Inc. ("PSC")

Ave. 65 de Infantería, Km. 9.5 San Gabriel Industrial Park, Carolina, Puerto Rico 00985

Panasonic Canada Inc.

5770 Ambler Drive, Mississauga, Ontario L4W 2T3 [www.panasonic.ca](http://www.panasonic.ca)



Portable CD player

Panasonic

Dear Customer

Thank you for purchasing this product. For optimum performance and safety, please read these instructions carefully.

Operating Instructions

SL-SW505/SL-SW515  
SL-SW511C

SL-SW511C ONLY

To install this product in a car, please refer to the "Installation Instructions" (attached sheet).

The SL-SW511C model is only for Canada.

The model number and serial number of this product can be found on either the back or the bottom of the unit. Please note them in the space provided below and keep for future reference.

MODEL NUMBER \_\_\_\_\_

SERIAL NUMBER \_\_\_\_\_



## Supplied Accessories

Check the packing carton for these accessories.

AC adaptor (RFEA415C-S) .....	1 pc.
Stereo headphones .....	1 pc.
<b>SL-SW505</b>	
For U.S.A. [RFEV701P-A1S (blue) or RFEV701P-Y1S (yellow)]	
For Canada [RFEV701P-Y1S]	
<b>SL-SW515</b>	
For U.S.A. [RFEV707P-S1S]	
For Canada [RFEV707P-S1S (silver) or RFEV707P-A1S (blue)]	
<b>SL-SW511C (RFEV701P-K1S)</b>	
<b>SL-SW511C ONLY</b>	
Car adaptor (SH-CDC11PCY) .....	1 pc.
Car stereo cassette adaptor (SH-CDM10BPYK) .....	1 pc.

Use numbers indicated in parentheses when asking for replacement parts. (Only for U.S.A.) To order accessories contact 1-800-332-5368 or web site (<http://www.panasonic.com>).

Before connecting, operating or adjusting this product, please read these instructions completely. Please save this manual.



## Precautions

Before using this unit, be sure to read the applicable items of the operating instructions and these safety suggestions carefully.

Afterwards keep them handy for future reference. Take special care to follow the warnings indicated on the unit itself as well as in the operating instructions.

- Batteries**—If the set is not used for a long period of time or is used only from an AC power source, remove all the batteries to prevent potential damage due to possible battery leakage. Do not mix batteries (old and new) or different types of batteries.

## Installation

### Environment

- Water and Moisture**—Do not use this unit near water—for example, near a bathtub, washbowl, swimming pool, or the like. Damp basements should also be avoided.
- Condensation**—Moisture may form on the lens in the following conditions...
  - immediately after a heater has been turned on.
  - in a steamy or very humid room.
  - when the unit is suddenly moved from a cold environment to a warm one. If moisture forms inside this unit, it may not operate properly. To correct this problem wait about one hour for the moisture to evaporate.
- Heat**—Never use or place this unit near a heat source. Do not leave it in an automobile exposed to direct sunlight for a long time with the doors and windows closed as this may deform the cabinet.

### Placement

- Foreign Material**—Care should be taken so that objects do not fall into and liquids are not spilled into the unit. Do not subject this unit to excessive smoke, dust, mechanical vibration, or shock.
- Magnetism**—The unit should be situated away from equipment or devices that generate strong magnetic fields.
- Stacking**—Do not place any objects, on top of the unit.

## Maintenance

(See page 7 for details.)

Clean the cabinet, panel and controls with a soft cloth lightly moistened with mild detergent solution. Do not use any type of abrasive pad, scouring powder or solvent such as alcohol or benzene.

## Service

- Damage Requiring Service**—The unit should be serviced by qualified service personnel when:
  - The AC adaptor is damaged; or
  - Objects have fallen or liquid has been spilled into the unit; or
  - The unit has been exposed to rain; or
  - The unit does not appear to operate normally or exhibits a marked change in performance; or
  - The unit has been dropped, or the enclosure damaged.
- Servicing**—The user should not attempt to service the unit beyond that described in the operating instructions. All other servicing should be referred to an authorized service personnel.  
**For the address of an authorized servicenter:**  
In the U.S.A. 1-800-211-7262 or web site (<http://www.panasonic.com>)  
In Canada 905-624-5505 or web site ([www.panasonic.ca/fdbckca.htm](http://www.panasonic.ca/fdbckca.htm))



This manual was printed with soy based ink.

RQT4436-1P  
F0298W1038 (D)

# Power Supply Preparations

Refer to the specifications (page 8) for information on operating times when using rechargeable batteries or dry-cell batteries.

## Using the AC adaptor

Take off the attached rubber cap and connect the AC adaptor supplied.

DC IN jack (DC IN 4.5 V  $\leftarrow$   $\rightarrow$   $\leftarrow$   $\rightarrow$ )

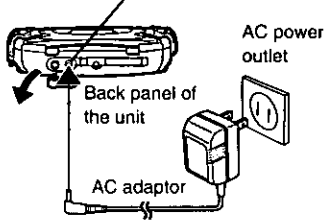

## Using rechargeable batteries (not included)

Obtain the optional rechargeable batteries.

- Optional batteries (P-3GAVA/2B, SH-CDB8D)
- Make sure to recharge the batteries before using them. The unit cannot be used to charge rechargeable batteries other than those specifically designed for it.

### Recharging procedure

#### 1 Open the disc lid.

Open and close dual locks using both hands at the same time.

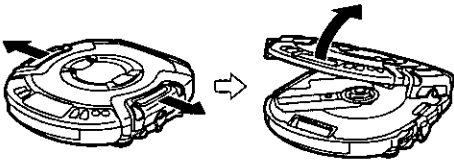

#### 2 Open the battery compartment lid, and place the rechargeable batteries inside the unit.

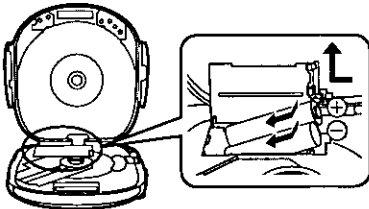

#### 3 Take off the attached rubber cap and connect the AC adaptor.

Refer to "Using the AC adaptor" for instructions. When recharging starts, the "CD" charging indicator flashes on and off on the unit's display.

#### 4 When recharging is complete, unplug the AC adaptor from the power outlet and the DC IN jack.

### Notes

- Rechargeable batteries have a service life of approximately 300 charge-discharge cycles. If the operating time on one full charge becomes noticeably shorter than it used to be, the battery has reached the end of its service life and should be replaced.
- Recharging may only be performed when the unit is powered off. (It is not possible to recharge the batteries while playing a CD.)
- The AC adaptor and rechargeable batteries may become warm while recharging is in progress. This is not a malfunction.

#### If the battery compartment lid comes loose

Insert the protrusions on the lid into the cutouts on both sides of the compartment.

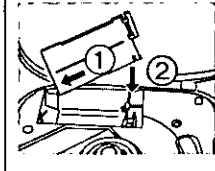

#### Removing batteries

Push up on the battery in the direction indicated by the arrow, then lift out.

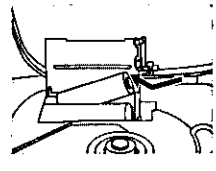

## Using the car adaptor

The SL-SW511C comes with a car adaptor. Be sure to use the adaptor specially designed for this model. (Refer to the separate installation instructions.)

Be sure to obtain the car adaptor (SH-CDC9), available as an optional accessory for SL-SW505 and SL-SW515. The car adaptor can be used to recharge the unit's batteries while in the car.

### For SL-SW505/SL-SW515

#### CAUTION:

Use only car adaptor, Model: SH-CDC9 manufactured by Matsushita Electric Industrial Co., Ltd.

## Using dry-cell batteries (not included)

After disconnecting the AC adaptor, insert two "AA" (LR6) alkaline batteries.

The procedure for inserting and removing dry-cell batteries is identical to that for rechargeable batteries.

## Battery indicator



This indicator flashes on and off when the batteries are almost out of power. Power is cut off completely a short while later.

**Rechargeable batteries: Recharge batteries.**  
**Dry-cell batteries: Replace batteries with new ones.**

### Notes

- The length of time the unit will continue to operate between when the battery indicator starts flashing and when the power is cut off differs depending on the type of batteries used.
- The battery indicator may not flash if rechargeable batteries, other than those designated by Panasonic, are used.

**If the unit malfunctions or freezes during use, then disconnect the power sources (the AC adaptor and batteries). Re-connect the power source and continue operation.**

# HOLD Function

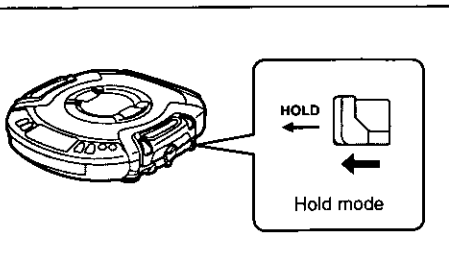

This function causes the unit to ignore short, accidental button presses. (The disc lid can still be opened and closed.)

#### The HOLD function prevents the following:

- Powering on the unit accidentally (which can cause the batteries to go dead).
- Play being cut off unexpectedly in the middle of a selection.

**To use the HOLD function**  
Set HOLD to the HOLD position.

#### "ho!d" indication

When the unit is in hold status, pressing any button causes the indication "ho!d" to appear on the display.

#### When the unit is powered off

The "ho!d" indication appears only when  $\blacktriangleright \parallel$  is pressed.

#### Before operating the buttons

Be absolutely sure to move HOLD to release the unit from the hold mode.



Side panel of the unit



Back panel of the unit

Be sure to cover the headphones jack, OUT jack and DC IN jack with the rubber caps when they are not in use.

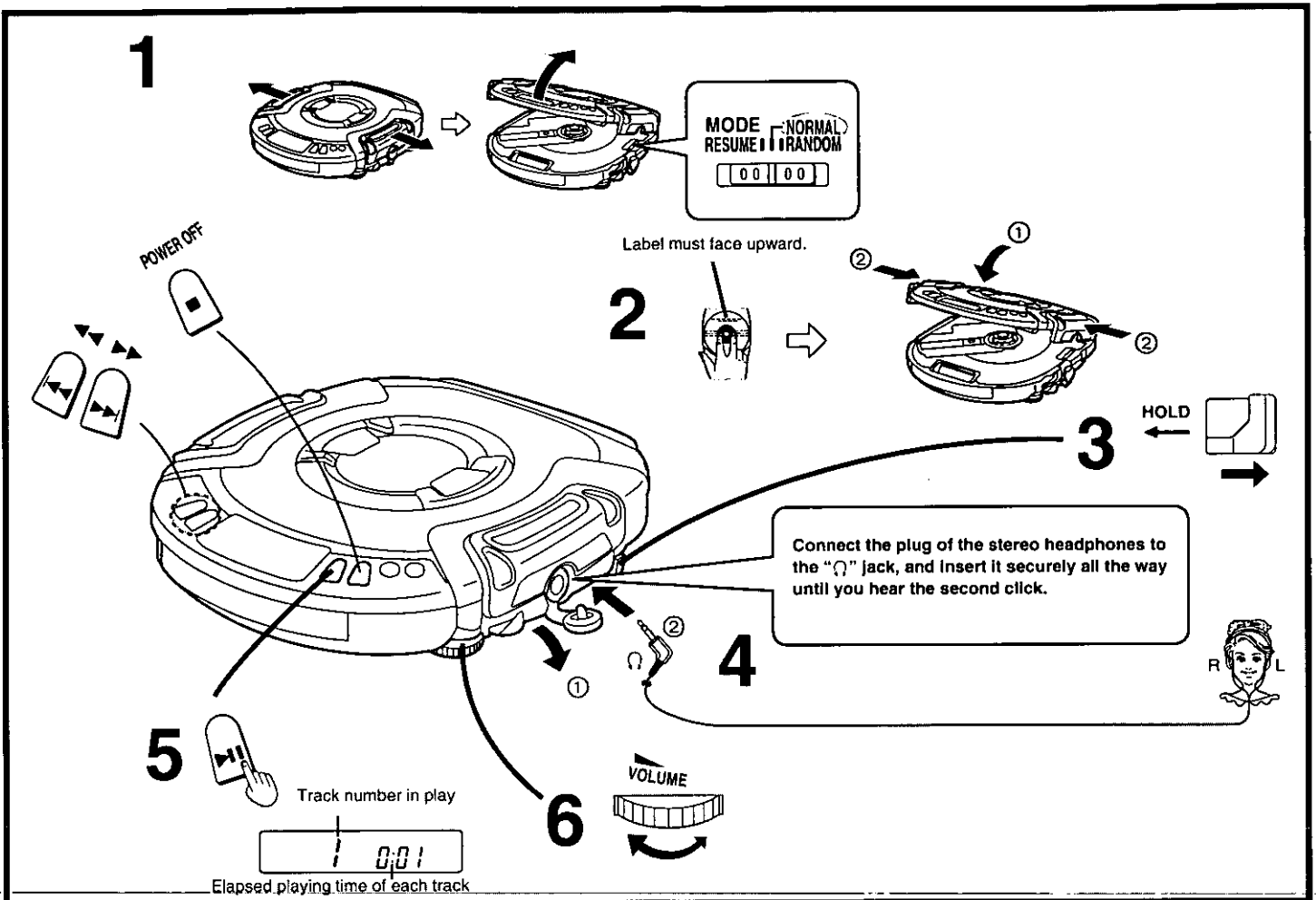

### Follow steps 1-6.

- Play stops automatically when all the tracks have been played.
- If the unit has been connected to the car audio system, adjust the volume level between 4 and 6 on the unit, then adjust the volume level on the system.

### For your reference:

#### "no disc" indication

This indication appears for about 30 seconds if ►|| is pressed when no disc is loaded in the unit or if the disc is not completely seated.

#### "OPEN" indication

This indication appears for about 10 minutes when the cover is opened. (However, the indication does not appear when the unit is powered off.)

#### Notes

- When you open and/or close the lid, be sure to disconnect the stereo headphones plug from the headphones jack to avoid accidental breakage.
- Never insert foreign objects into the unit body.

#### Removing discs

After the disc has stopped rotating, press the PUSH button to release the disc. (To protect the disc, never open the cover while it is playing.)

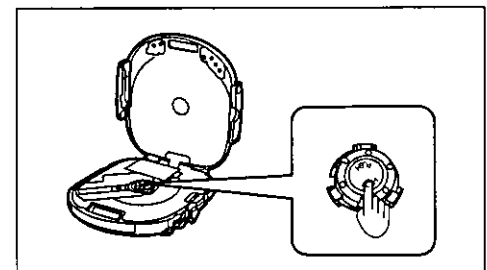

#### Auto power off function

If the unit is left in stop or paused status for approximately 10 minutes, the unit powers itself off automatically in order to prevent the battery from running down. (If no disc is loaded in the unit, it powers itself off in about 30 seconds.)

Operation	Button	Display/reference
To pause play	Press during play	 Press again to resume play
To stop play <b>Stop mode</b>	Press during play <b>POWER OFF</b>	Total number of tracks  Total playing time
To turn off the unit <b>Off mode</b>	Press during stop mode <b>POWER OFF</b>	
Skip forward/ backward (skip function)	Press during play	<ul style="list-style-type: none"> <li>• During program play, these buttons are used to skip forward or back through the programmed sequence of tracks.</li> <li>• During random play, the skip buttons cannot be used to skip back to tracks that were played previously in the random sequence.</li> <li>• During program play, random play or 1 track repeat play, search operation is limited to the current track only.</li> </ul>
Rapid forward/ backward (search function)	(Backward) (Forward) Keep depressed during play	(See page 4.)

# Other Play Methods

The letters such as **A** in the various illustrations refer to the descriptions in the following "Location of Controls" section.

## Skip play

The disc plays from the specific track through to the end, then play stops automatically.

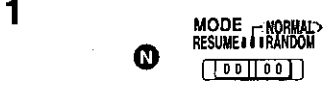

Preparation: Put unit in stop mode.

### 2 Select the desired track.



## Random play



### For your reference:

- It is also possible to press **▶▶** while unit is in stop status to change the first track to be played. (All tracks are played eventually, regardless of which is played first.)
- Program play is not possible in the random mode.

## Resume play

This function allows you to listen from the beginning of the track where play stopped because the unit was powered off (or switched to stop status). It is useful when listening to CDs in the car, etc.

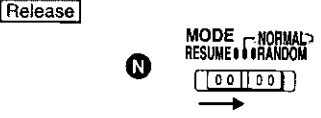

### For your reference:

- If the MODE (play mode) selector is put in the RESUME position, the all-track repeat function will be activated automatically as soon as the unit is powered on.
- If power is cut off near the end of a track (power off status), playback may resume from the beginning of the next track in some cases.
- If the unit is powered off while a disc was playing and then a new disc is inserted, play will begin from the middle of the new disc because the unit remembers the position where play stopped on the old disc.

## Program play

Up to 24 tracks can be entered in the programmed sequence.

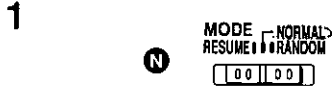

Preparation: Put unit in stop mode.

### 2 Select the desired track.

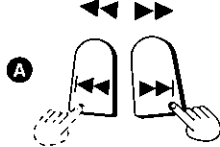

### 3 Register in sequence.

(The indication "M" and the programmed sequence appear on the display panel.)



### 4 Repeat steps 2 and 3 to program all the desired tracks.



#### ■ To program the same track in the sequence more than once

After step 3, press MEMORY/RECALL the desired number of times.

#### ■ If "f" is displayed

No more tracks may be added to the sequence.

#### ■ To confirm the contents of the programmed sequence

Press MEMORY/RECALL while the disc is playing. (The number of the programmed tracks appear on the display panel in sequence.)

#### ■ To delete the entire programmed sequence

Press **■**, POWER OFF.

## Repeat function

Press REPEAT while disc is playing or when unit is in stop status.



The setting is switched in the sequence indicated below each time REPEAT is pressed.

### 1-track repeat (1)

One track is repeated.

### All-track repeat (ALL)

All the tracks on the disc are repeated.

### Cancel

### For your reference:

If REPEAT is pressed during program play, only the tracks in the programmed sequence are repeated. (The indication "ALL" is not displayed.)

## Changing the sound quality

### SL-SW505/SL-SW511C

#### XBS ON:

Select this setting to boost the low-range response.



#### OFF:

Select this setting to turn off the XBS function.



### SL-SW515

#### VMSS ON:

Boosts the low frequency range. The vibration of the earpieces of the included headphones makes the sound more vigorous.

Raising the volume level makes the VMSS effect intensify.



#### OFF:

Select this setting to turn off the VMSS functions.



### Notes

- VMSS is less effective with some sources.
- If you experience ringing or discomfort in your ears while in VMSS mode, reduce volume or turn VMSS OFF.

# Location of Controls

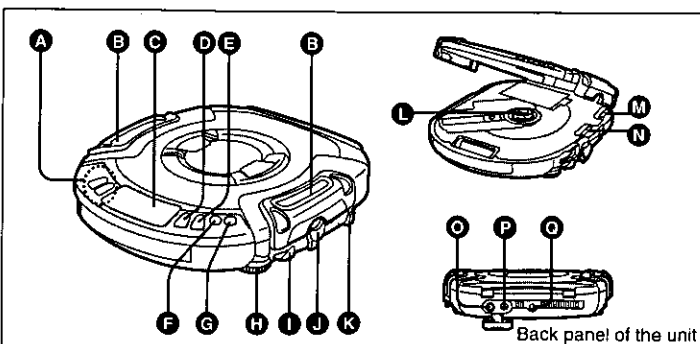

- A** Skip/search buttons (◀, ▶, ◀◀, ▶▶)
- B** Dual lock (OPEN)
- C** Display
- D** Play/pause button (▶ ||)
- E** Stop/power off button (■, POWER OFF)
- F** Memory/recall button (MEMORY/RECALL)
- G** Repeat button (REPEAT)
- H** Headphones volume control (VOLUME)

- I** SL-SW505/SL-SW511C XBS switch (XBS)
- J** SL-SW515 VMSS switch (VMSS)
- K** Headphones jack (⌀)
- L** Hold switch (HOLD)
- M** CD release button (PUSH)
- N** Anti-shock switch (ANTI-SHOCK)
- O** Play mode selector (MODE)
- P** Out jack (OUT)
- Q** DC in jack (DC IN 4.5 V ⌀-⌀)
- R** Hole for car mounting base

Back panel of the unit

# Anti-Shock Function

Anti shock works by reading audio data and storing it in memory (up to 40 seconds worth). The unit then fills in interruptions caused by bumps and vibrations with data from the memory. This unit also incorporates a powerful anti-shock mechanism that prevents skipping caused when play speed is changed by swinging of the unit.

1



2



M.RESERVE indicator status	Unit body status	Play status (audio data status)
	Stable	Normal (plenty of data is stored)
	Bump encountered	Normal (stored data is used)
	Bumping stops	Normal (data again starts to be stored)
	Bumps continue repeatedly	Sound is interrupted (data buffer empty)

### Notes

- The ANTI-SHOCK control cannot be set while play is in progress. Stop play, open the cover and then select the setting for this control.
- During anti-shock operation, the disc rotates at a higher rate than usual in collecting extra audio data. This could result in a slight increase in disc rotation noise.

### Using the unit with an audio system

The anti-shock uses digital signal compression technology. It is recommended that the anti-shock be kept in the OFF position if the unit is connected to a home audio system.

# Using the Unit with Optional Accessories

## Using the unit with an audio system

Using a stereo connection cable (not included), you can listen to CDs through your audio system.

- Connect the cable to the amplifier after turning off its power.
- Do not connect the cable to the PHONO jacks on the amplifier.
- Obtain the optional connecting cable if the amplifier comes with mini-phone jacks.
- Adjust the volume level on the amplifier.

### Note

Sound quality changes when XBS (SL-SW505/SL-SW511C) or VMSS (SL-SW515) is selected, but volume is reduced by approximately fifty percent.

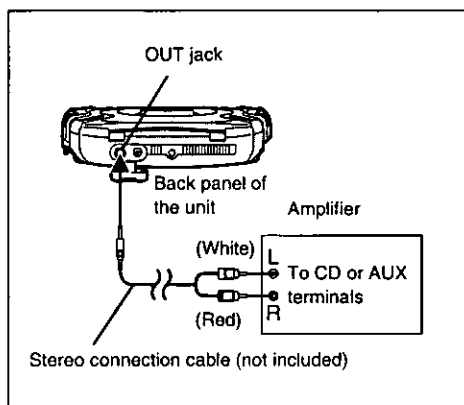

## Using the unit with a car audio system

SL-SW511C comes with a car adaptor and car stereo cassette adaptor.

### Items to be purchased (SL-SW505/SL-SW515)

For connection to the car audio system:  
Car stereo cassette adaptor (SH-CDM10A)

**Connect the car stereo cassette adaptor to the unit's headphone jack. (When doing this, keep the unit's VOLUME control at a setting between 5 and 8.)**

### For securing the unit and connecting the power supply:

- Car mounting kit (SH-CDF20)
- Car adaptor (SH-CDC9)

### Note

It may not be possible to use the unit with some types of car stereo owing to restrictions imposed by the construction of the car stereo cassette adaptor.

For further details, refer to the instructions of the part concerned.

**For Product Information, Operating Assistance, Literature Request, Dealer Locations, and all Customer Service inquiries please contact:  
800-211-PANA (7262), Monday-Friday 9 am-9 pm Saturday-Sunday 9 am-7 pm, EST.**

**Web Site: <http://WWW.Panasonic.com>  
You can purchase parts, accessories or locate your nearest servicer by visiting our Web Site.**

**Accessory Purchases:**

Customer Orders Only 800-211-PANA (7262)

**Factory Servicenters Locations**

<p><b>CALIFORNIA</b> 6550 Katella Avenue Cypress, CA 90630</p> <p>800 Dubuque Avenue S. San Francisco CA 94080</p> <p>20201 Sherman Way Suite 102 Canoga Park, CA 91306</p> <p>3878 Ruffin Road Suite A San Diego, CA 92123</p> <p><b>COLORADO</b> 1640 South Abilene Street Suite D Aurora, CO 80012</p> <p><b>FLORIDA</b> 3700 North 29<sup>th</sup> Avenue Suite 102 Hollywood, FL 33020</p>	<p><b>GEORGIA</b> 8655 Roswell Road Suite 100 Atlanta, GA 30350</p> <p><b>ILLINOIS</b> 1703 North Randall Road Elgin, IL 60123 (Pick-up/Drop-off only)</p> <p>9060 Golf Road Niles, IL 60714</p> <p><b>MARYLAND</b> 62 Mountain Road Glen Burnie, MD 21061</p> <p><b>MASSACHUSETTS</b> 60 Glacier Drive Suite G Westwood, MA 02090</p>	<p><b>MICHIGAN</b> 37048 Van Dyke Avenue Sterling Heights, MI 48312</p> <p><b>MINNESOTA</b> 7850-12<sup>th</sup> Avenue South Airport Business Center Bloomington, MN. 55425</p> <p><b>OHIO</b> 2236 Waycross Road Civic Center Plaza Forest Park, OH 45240</p> <p><b>PENNSYLVANIA</b> 2221 Cabot Blvd. West Suite B Langhorne, PA 19047</p> <p>Chartiers Valley Shopping Center 1025 Washington Pike Bridgeville, PA 15017</p>	<p><b>TENNESSEE</b> 919-8<sup>th</sup> Avenue South Nashville, TN 37203</p> <p><b>TEXAS</b> 7482 Harwin Drive Houston, TX 77036</p> <p>13615 Welch Road Suite 101 Farmers Branch, TX 75244</p> <p><b>WASHINGTON</b> 20425-84<sup>th</sup> Avenue South Kent, WA 98032</p> <p><b>HAWAII</b> 99-859 Iwaiwa Street Aiea, Hawaii 96701 Phone (808) 488-1996 Fax (808) 486-4369</p>
---	--	---	--

**Service in Puerto Rico**  
**Matsushita Electric of Puerto Rico, Inc. Panasonic Sales Company/Factory Servicer.**  
**Ave. 65 de Infanteria, Km. 9.5, San Gabriel Industrial Park, Carolina, Puerto Rico 00985.**  
**Phone (787) 750-4300 Fax (787) 768-2910**

Panasonic Consumer Electronics Company, Division of Matsushita Electric Corporation of America  
One Panasonic Way,  
Secaucus, New Jersey 07094

ONLY FOR U.S.A.

**Panasonic Audio Products  
Limited Warranty**

Panasonic Sales Company, Division of Matsushita Electric of Puerto Rico, Inc. ("PSC")  
Ave. 65 de Infanteria, Km. 9.5  
San Gabriel Industrial Park  
Carolina, Puerto Rico 00985  
Tel. (809) 750-4300  
FAX. (809) 768-2910

Panasonic Consumer Electronics Company or Panasonic Sales Company (collectively referred to as "The warrantor") will repair this product with new or refurbished parts, free of charge, in the U.S.A. or Puerto Rico from the date of original purchase in the event of a defect in materials or workmanship as follows:

**AUDIO COMPONENTS, RADIOS, COMPACT DISC PLAYERS, VIDEO CD PLAYERS AND HOME ENTERTAINMENT SYSTEMS**—For one (1) year.

**ACCESSORIES, HEADPHONES AND CARTRIDGES**—(when applicable) For ninety (90) days.

**BATTERIES**—(when applicable)—New rechargeable batteries in exchange for defective rechargeable batteries—For ten (10) days. Non-rechargeable batteries are not warranted.

**RECHARGEABLE BATTERY PACKS**—(when applicable)—New rechargeable battery packs in exchange for defective rechargeable battery packs for (90) days. Non-rechargeable battery packs are not warranted.

Carry-in or mail-in service in the continental U.S.A. can be obtained during the warranty period from a Panasonic Services Company (PASC) Factory Servicer listed in the Servicer Directory. Or call 1-800-211-7262, toll free, to locate an authorized PASC Servicer. Carry-in or mail-in service in Puerto Rico can be obtained during the warranty period by calling the telephone numbers listed in the Servicer Directory.

This warranty is extended only to the original purchaser. A purchase receipt or other proof of date of original purchase will be required before warranty service is rendered.

This warranty only covers failures due to defects in materials or workmanship

which occur during normal use and does not cover normal wear to the stylus (when applicable) or dealer installed cartridge or stylus. It does not cover damage which occurs in shipment or failures which are caused by products not supplied by the warrantor or failures which result from accident, misuse, abuse, neglect, mishandling, misapplication, faulty installation, set-up adjustment, improper maintenance, alteration, improper antenna, inadequate signal pick-up, maladjustment of consumer controls, modification, or commercial use of product, or service by anyone other than a PASC Factory Servicer or authorized PASC Servicer, or damage that is attributable to acts of God.

**LIMITS AND EXCLUSIONS**

There are no express warranties except as listed above.

THE WARRANTOR SHALL NOT BE LIABLE FOR INCIDENTAL OR CONSEQUENTIAL DAMAGES RESULTING FROM THE USE OF THIS PRODUCT, OR ARISING OUT OF ANY BREACH OF THIS WARRANTY, INCLUDING WITHOUT LIMITATION, DAMAGE TO TAPES RECORDS OR DISCS. ALL EXPRESS AND IMPLIED WARRANTIES INCLUDING THE WARRANTIES OF MERCHANTABILITY AND FITNESS FOR A PARTICULAR PURPOSE, ARE LIMITED TO THE APPLICABLE WARRANTY PERIOD SET FORTH ABOVE. Some states do not allow the exclusion or limitation of incidental or consequential damages, or limitations on how long an implied warranty lasts, so the above exclusions or limitations may not apply to you.

This warranty gives you specific legal rights and you may also have other rights which vary from state to state.

If a problem with this product develops during or after the warranty period, you may contact your dealer or Servicer. If the problem is not handled to your satisfaction, then write to the Consumer Affairs Division at the company address indicated above.

## Product Service

Do not attempt to remove the cover(s) or repair the unit yourself. Refer servicing to qualified personnel only.

### Product information

For product service, product information or assistance with product operation, refer to the servicenter directory.

#### User memo:

DATE OF PURCHASE \_\_\_\_\_  
 DEALER NAME \_\_\_\_\_  
 DEALER ADDRESS \_\_\_\_\_  
 TELEPHONE NUMBER \_\_\_\_\_

## Maintaining the Lens

Open the lid and clean the lens as shown in the figure. Use a cotton swab to gently wipe off any finger-prints. Recommended product: Lens cleaner kit (SZZP1038C)

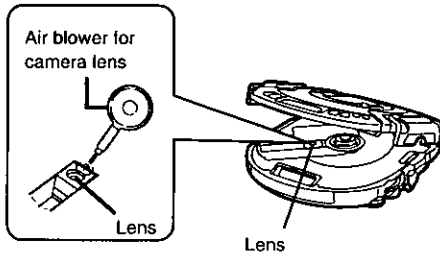

## WARNING:

TO REDUCE THE RISK OF FIRE, ELECTRIC SHOCK OR PRODUCT DAMAGE, DO NOT EXPOSE THIS APPLIANCE TO RAIN, SPLASHING, DRIPPING OR MOISTURE.

## CAUTION!

THIS PRODUCT UTILIZES A LASER. USE OF CONTROLS OR ADJUSTMENTS OR PERFORMANCE OF PROCEDURES OTHER THAN THOSE SPECIFIED HEREIN MAY RESULT IN HAZARDOUS RADIATION EXPOSURE. DO NOT OPEN COVERS AND DO NOT REPAIR YOURSELF. REFER SERVICING TO QUALIFIED PERSONNEL.

The product you have purchased is powered by a nickel-cadmium battery which is recyclable. Please call 1-800-8-BATTERY for information on how to recycle this battery.



THE FOLLOWING APPLIES ONLY IN THE U.S.A.

## CAUTION:

This equipment has been tested and found to comply with the limits for a Class B digital device, pursuant to Part 15 of the FCC Rules. These limits are designed to provide reasonable protection against harmful interference in a residential installation. This equipment generates, uses and can radiate radio frequency energy and, if not installed and used in accordance with the instructions, may cause harmful interference to radio communications. However, there is no guarantee that interference will not occur in a particular installation. If this equipment does cause harmful interference to radio or television reception, which can be determined by turning the equipment off and on, the user is encouraged to try to correct the interference by one of the following measures:

- Reorient or relocate the receiving antenna.
- Increase the separation between the equipment and receiver.
- Connect the equipment into an outlet on a circuit different from that to which the receiver is connected.
- Consult the dealer or an experienced radio/TV technician for help.

Any unauthorized changes or modifications to this equipment would void the user's authority to operate this device.

This device complies with Part 15 of the FCC Rules. Operation is subject to the following two conditions: (1) This device may not cause harmful interference, and (2) this device must accept any interference received, including interference that may cause undesired operation.

### If you ship the product

Carefully pack and send it prepaid, adequately insured and preferably in the original carton. Attach a postage-affixed letter, detailing the complaint, to the outside of the carton.

*Do NOT send the product to the Executive or Regional Sales offices. They are NOT equipped to make repairs.*

### Customer's Record

Model No. _____	Dealer's Name _____
Serial No. _____ or _____	_____
Code No. _____	Dealer's Address _____
Date of Purchase _____	_____

# Specifications

**Audio**  
 No. of channels: 2 (left and right, stereo)  
 Frequency response: 20 to 20,000 Hz (+0.5 dB, -1.5 dB)  
 Output voltage: 0.6 V (50 kΩ)  
 S/N: More than 94 dB\*  
 Wow and flutter: Below measurable limit  
 DA converter: 1 bit, MASH  
 Headphones output level: Max. 9 mW+9 mW/16Ω (variable)

**Pickup**  
 Light source: Semiconductor laser  
 Wavelength: 780 nm

**General**  
 Operational temperature range: 0°C-40°C (32°F-104°F)

Rechargeable temperature range: 5°C-40°C (41°F-104°F)

Power supply: DC 4.5 V

Power consumption:

Power source	Anti shock OFF/ON
Using AC adaptor	2.3 W/2.5 W

When recharging: 3.8 W

Play time: [When used in hold mode, at 25°C (77°F) temperature and on flat and stable surface]

Batteries used	Anti-shock OFF/ON
2 alkaline batteries	About 18 h/20 h
Optional rechargeable batteries	P-3GAVA/2B About 9.0 h/10 h SH-CDB8D About 5.0 h/6.0 h

The play time may be less depending on the operating conditions.

Recharging time  
 P-3GAVA/2B: About 5 hours  
 SH-CDB8D: About 3 hours  
 Dimension (W×H×D): 136×30.0×150 mm (5<sup>1</sup>/<sub>2</sub>"×1<sup>3</sup>/<sub>16</sub>"×5<sup>2</sup>/<sub>32</sub>"

Weight: 359 g (12.6 oz) (with batteries)  
 314 g (11.0 oz) (without batteries)

\*These specifications were measured in the anti-shock OFF mode.

**Note:**  
 Specifications are subject to change without notice.  
 Weight and dimensions are approximate.

MASH is a trademark of NTT.

# Troubleshooting Guide

Before requesting service for this unit, check the chart below for a possible cause of the problem you are experiencing. Some simple checks or a minor adjustment on your part may eliminate the problem and restore proper operation.

If you are in doubt about some of the check points, or if the remedies indicated in the chart do not solve the problem, refer to the directory of Authorized Service Centers (enclosed with this unit) to locate a convenient service center, or consult your dealer for instructions.

For detailed instructions, contact an authorized servicenter in the U.S.A. and Panasonic Canada Inc. Customer Care Center in Canada. In the U.S.A. 1-800-211-7262 or web site (<http://www.panasonic.com>) in Canada 905-624-5505 or web site ([www.panasonic.ca/faq.html](http://www.panasonic.ca/faq.html))

Problem	Check this
Cannot close cover.	Is the disc properly secured in place?
Cannot play discs.	<ul style="list-style-type: none"> <li>Is the unit in hold status?</li> <li>Is the disc properly secured in place?</li> <li>Is there moisture condensation on the lens? (Wait for about an hour and then try again.)</li> </ul>
Cannot remove disc.	Did you press the PUSH button to release the disc?
Tracks on disc do not play in order, starting with the first track.	Is the MODE (play mode) slider in the NORMAL position?
Cannot hear music—too noisy.	<ul style="list-style-type: none"> <li>Is the headphones plug inserted all the way?</li> <li>Is the plug dirty? (Wipe away dirt on plug.)</li> </ul>
TV picture is distorted. Radio reception is noisy.	Are you using the unit body too near a TV or tuner? (If the TV or tuner is connected to a simple indoor antenna, connect it to an outdoor antenna.)

# Cautions

## Water Resistant (Splash Proof)

This unit is splash-proof and is not designed to be used under water.

Please note the following points to avoid possible damage to the unit and the included headphones.

- Do not immerse in water.
- Do not splash water onto the unit.
- Water in the headphones jack, OUT jack, and DC IN jack may damage the unit. Cover them with the attached rubber caps when they are not in use.
- To prevent water from entering the unit, the dual locks should be locked to close the disc lid.
- If the unit or the headphones get wet with water or sweat, dry them with a soft cloth.
- Do not open the disc lid near water or sand. Before opening or closing the disc lid, be sure to wipe off water, dust or sand on the unit and operate with a dry hand.
- Make sure there is no sand or dust around the disc lid. The disc lid will not seal properly if there is, and water may get into the unit, possibly causing a malfunction.
- Do not expose the unit or the headphones to salt water. If the unit and headphones are immersed in salt water, wash them with a little fresh water then dry with soft cloth. Never wash them under running water.
- Do not place the unit and the headphones for a long period of time in high temperature and high humidity areas such as bathrooms or damp basements, etc.

## Rechargeable batteries

- Only the P-3GAVA/2B, SH-CDB8D batteries can be recharged.
- If the power delivered by the batteries lasts for a very short time after recharging, it means that the batteries' service life is over. Do not use them any more.
- Recharging already charged batteries will shorten their service life.
- When recharging batteries for the first time or when they have not been used for a long period of time, the play time may be shorter than usual. In a case like this, repeatedly recharge and discharge the batteries. This will restore them to their regular state.
- Do not allow any metal objects to touch the terminals of rechargeable batteries since this may cause short-circuiting which is dangerous.
- Do not peel off the plastic covering on the rechargeable batteries. Short-circuiting may occur which is dangerous.

## Dry cell batteries/rechargeable batteries

To prevent damage to the batteries and electrolyte leakage, heed the following points.

- Align the ⊕ and ⊖ polarities properly when inserting the batteries.
- Do not mix different types or makes of batteries or old and new batteries.
- Remove the batteries if you do not plan to use the unit for a long period of time.
- Do not throw batteries into a fire, and do not short-circuit, disassemble or subject them to excessive heat.
- Do not attempt to recharge dry cell batteries.

## Carrying dry cell batteries/rechargeable batteries around

When putting dry cell or rechargeable batteries in a pocket or bag, ensure that no other metal objects such as a necklace are placed together with them. Contact with metal may cause short-circuiting which, in turn, may cause a fire. Be absolutely sure to carry the rechargeable batteries in the battery carrying case.

## When purchasing rechargeable batteries

As a safety precaution, the portable CD players made by Panasonic have a construction designed to make it impossible to recharge ordinary batteries.

To use rechargeable batteries, be absolutely sure to purchase the rechargeable Ni-Cd batteries designed especially for this unit.

### Special rechargeable Ni-Cd batteries:

P-3GAVA/2B, SH-CDB8D (set of 2)

For details, check with your dealer.

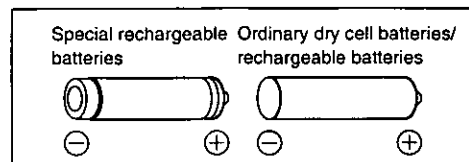

## When driving a car

In the interest of traffic safety, do not operate the unit while driving.

## Listening caution



Do not play your headphones or earphones at a high volume. Hearing experts advise against continuous extended play.

If you experience a ringing in your ears, reduce volume or discontinue use.

Do not use while operating a motorized vehicle. It may create a traffic hazard and is illegal in many areas.

You should use extreme caution or temporarily discontinue use in potentially hazardous situations.

Even if your headphones or earphones is an open-air type designed to let you hear outside sounds, don't turn up the volume so high that you can't hear what's around you.

Sound can be deceiving. Over time your hearing "comfort level" adapts to higher volumes of sound. So what sounds "normal" can actually be loud and harmful to your hearing.

Guard against this by setting your equipment at a safe level BEFORE your hearing adapts.

To establish a safe level:

- Start your volume control at a low setting.
- Slowly increase the sound until you can hear it comfortably and clearly, and without distortion.

Once you have established a comfortable sound level:

- Set the dial and leave it there.